

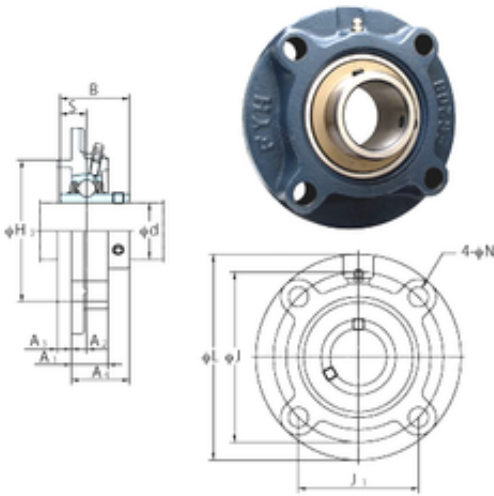

Air Suspension Bearing Co., Ltd

FYH UCFC201-8 bearing units

Bearing No. UCFC201-8



UCFC201-8 Bearing 2D drawings and 3D CAD models

Bore Diameter	12,7 mm
d	12,7 mm
H3	62 mm
A4	28,3 mm
A1	20,5 mm
B	31 mm
J	78 mm
L	100 mm
N	12 mm
S	12,7 mm
Bolt (G)	M10
A2	10 mm
A3	5 mm
J1	55,1 mm
Weight	0,78 Kg
Basic dynamic load rating (C)	12,8 kN
Basic static load rating (C0)	6,65 kN